



YOUR ELECTRICAL EXPERTS

# Essential Lighting Solutions



Fusion Luminaires Lighting Range 2 -15

Fusion Lamps Range 16 - 27

May 2026 - V1

# Free of Charge Services

Exclusive Services for CEF customers from Fusion Luminaires

Our **FREE** services include:

-  **External Field Support**  
Ensures reliable, on-site expertise for maintaining, repairing, and optimizing lighting systems
-  **Product Demonstration**  
Help customers experience the quality, efficiency, and visual impact of lighting products before making a purchase.
-  **Nationwide Distribution/ Wholesale Network**  
Ensures efficient, reliable delivery of lighting products to customers across the country.
-  **Lighting Design Service**  
Plans, results overview, optional 3D renderings, full product specifications and optional energy savings report
-  **Energy Saving Audits**  
Reveal ways to cut energy use and enhance lighting performance.

Contact your local CEF branch for more details



Follow Fusion Luminaires on   

## LED FLOODLIGHTS

### Protector LED CCT Floodlights IP65

- Die-cast aluminium powder-coated body
- Can be mounted without removing bracket
- Selectable colour temperature:  
Warm white 3000K, cool white 4000K & Daylight 6500K
- Lamp life: 25,000 hrs
- Warranty: 3 Years

Fusion Ref	Code	Wattage	Max Lumens	Height	Width	Depth
<b>Standard</b>						
FPF10CC	2897-9923	10W	1000 lm	179 mm	133 mm	34 mm
FPF20CC	2897-9929	20W	2000 lm	179 mm	133 mm	34 mm
FPF30CC	2897-9935	30W	3000 lm	203 mm	133 mm	34 mm
FPF50CC	2897-9941	50W	5000 lm	226 mm	165 mm	34 mm
<b>PIR</b>						
FPF10CC/PIR	2897-9926	10W	1000 lm	201 mm	133 mm	62 mm
FPF20CC/PIR	2897-9932	20W	2000 lm	201 mm	133 mm	62 mm
FPF30CC/PIR	2897-9938	30W	3000 lm	225 mm	133 mm	62 mm
FPF50CC/PIR	2897-9944	50W	5000 lm	252 mm	165 mm	62 mm



Standard



PIR

Includes:

- Adjustable bracket
- 1 m Prewired cable

PIR Features:

- Detection angle: 120°
- Detection range: 10 m
- Timer adjustment: 3 secs - 8 mins

### Guardian LED Floodlights IP65

- Die-cast aluminium powder-coated body
- Can be mounted without removing bracket
- Colour temperature: Cool white 4000K
- Lumens per Wattage: 120lm/W
- Beam Angle: 110 x 45°
- Lamp life: 50,000 hrs
- Warranty: 3 Years

Fusion Ref	Code	Wattage	Max Lumens	Height	Width	Depth
FGF80ASY	2897-9920	180W	9600 lm	285 mm	204 mm	40 mm
FGF100ASY	2897-9902	100W	12000 lm	285 mm	204 mm	40 mm
FGF150ASY	2897-9905	1500W	18000 lm	346 mm	253 mm	45 mm
FGF250ASY	2897-9911	250W	30000 lm	475 mm	340 mm	55 mm



2897-9917



2897-9920

Includes:

- Adjustable bracket
- 1 m Prewired cable

## LED WALL PACKS

### 20W Tri-Colour LED Wall Packs IP65

- Die-cast aluminium body and polycarbonate diffuser
- Push-fit connectors for easy installation
- Selectable colour temperature:  
Warm white 3000K, cool white 4000K or daylight 6500K
- Lumen output: 1,500, 1,550 or 1,600 lm
- Lamp life: 50,000 hrs
- Warranty: 5 Years [on-site: 1 year]

Fusion Ref	Code	Sensor	Height	Width	Depth
FWPCC	2641-1884	No	221 mm	207 mm	82 mm
FWPCCPC	2641-1887	Photocell	221 mm	207 mm	82 mm



CCT COLOUR SELECT



Visit [cef.co.uk](http://cef.co.uk) for video demonstration

## LED CIRCULAR DOME BULKHEADS

### LED DOME II Wattage & CCT Selectable Bulheads IP65 Range

- Plastic body and polycarbonate diffuser
- Wattage selectable: 8W, 12W, 16W & 20W
- Selectable colour temperature:  
Warm white 3000K, cool white 4000K & Daylight 6500K
- Up to 2100 Lumens
- Beam angle: 115°
- LED Lifetime: 50,000hrs
- Optional Built-in microwave sensor
- Optional Maintained emergency (3hr/180mins)
- Optional clip-on bezels available

Fusion Ref	Code	Description
FDOMECCW	2897-8339	Dome Wattage & CCT Selectable LED Bulkhead
FDOMECCWE3	2897-8342	Dome Wattage & CCT Selectable LED Emergency Bulkhead
FDOMECCWS	2897-8345	Dome Wattage & CCT Selectable LED Sensor Bulkhead
FDOMECCWSE3	2897-8348	Dome Wattage & CCT Selectable LED Sensor Emergency Bulkhead



Includes:

- Push-fit (loop-in/loop-out) terminal block
- Side and rear 20mm cable entry points
- Twist & Lock diffuser and white clip-on bezel supplied
- Hinged LED Gear Tray with locking catch
- Plug-and-play component arrangement for ease of maintenance

### 12W Orbit LED Circular Bulkhead IP65



- Polycarbonate body and opal diffuser
- Colour temperature: Cool white 4000K
- Lumen output: 1200 lm
- Lamp life: 25,000 hrs
- Warranty: 3 Years



Includes:

- Fixing bracket
- 300 mm Prewired cable

Fusion Ref	Code	Depth	Ø
FORBIT	2719-8916	72 mm	221 mm
FORBITB	2719-8919	23 mm	226 mm
FORBITSN	2719-8928	23 mm	226 mm
FORBITBR	2719-8922	23 mm	226 mm
FORBITEB	2719-8925	23 mm	226 mm

### 6W Mini Orbit LED Circular Bulkhead IP65



- Polycarbonate body and opal diffuser
- Colour temperature: Cool white 4000K
- Lumen output: 600 lm
- Lamp life: 25,000 hrs
- Warranty: 3 Years



Includes:

- Fixing bracket
- 300 mm Prewired cable

Fusion Ref	Code	Depth	Ø
FMORBIT	2719-8898	62 mm	167 mm
FMORBITB	2719-8901	24 mm	171 mm
FMORBITSN	2719-8907	24 mm	171 mm
FMORBITEB	2719-8904	45 mm	171 mm

## LED AMENITY BULKHEADS

### 10W LED Oval Orbit Bulkhead IP65



- Polycarbonate body and opal diffuser
- Colour temperature: Cool white 4000K
- Lumen output: 1,000 lm
- Lamp life: 25,000 hrs
- Warranty: 3 Years

- Includes:  
■ Fixing bracket
- 300 mm Prewired cable



Fusion Ref	Code	Height	Width	Depth
FOORBIT	2719-8910	215 mm	115 mm	62 mm
FOORBITGB	2719-8913	220 mm	120 mm	50 mm

### 16W Quad LED Tri-Colour Square Bulkheads IP65



- Polycarbonate body and diffuser
- Selectable colour temperature: Warm white 3000K, cool white 4000K and daylight 6500K
- Lamp life: 30,000 hrs
- Dimensions: 250 mm[L] x 250 mm[W] x 90 mm[D]
- Warranty: 3 Years



Fusion Ref	Code	Colour	Diffuser	Lumens
<b>Standard</b>				
FQUADBOP16	2823-0181	Black	Opal	1600 lm
FQUADBP16	2823-0193	Black	Prismatic	1900 lm
FQUADWOP16	2823-0205	White	Opal	1600 lm
FQUADWP16	2823-0217	White	Prismatic	1900 lm
<b>3 hr Maintained Emergency</b>				
FQUADBOP16/E3	2823-0184	Black	Opal	1600 lm
FQUADBP16/E3	2823-0196	Black	Prismatic	1900 lm
FQUADWOP16/E3	2823-0208	White	Opal	1600 lm
FQUADWP16/E3	2823-0220	White	Prismatic	1900 lm

## LED BATTENS

### Tri-Colour LED Battens IP20

- Steel body with powder-coated finish
- Polycarbonate UV stabilised diffuser
- Quick-release access system with LED array safety cords, for easy installation
- Ideal retrofit option for existing T8 or T5 fixtures
- Colour temperature: Warm white 3000K, cool white 4000K and daylight 6500K
- Lamp life: 50,000 hrs
- Dimensions: 72 mm [W] x 72.5 mm [D]
- Mounted: Surface or suspended
- Warranty: 5 Years [on-site: 1 year]
- Emergency Warranty: 2 Years



Fusion Ref	Code	Size	Wattage	Sensor	Lumens	Length
<b>Standard</b>						
FBAT2CC	2756-5063	2 ft	10W	No	1200 lm	600 mm
FBAT4CC	2756-5066	4 ft	20W	No	2400 lm	1200 mm
FBAT4HOCC	2756-5075	4 ft	40W	No	4800 lm	1200 mm
FBAT5CC	2756-5081	5 ft	30W	No	3600 lm	1500 mm
FBAT5CCS	2756-5093	5 ft	30W	Microwave	3600 lm	1500 mm
FBAT5HOCC	2756-5099	5 ft	60W	No	7200 lm	1500 mm
FBAT5HOCCS	2756-5105	5 ft	60W	Microwave	7200 lm	1500 mm
FBAT6CC	2756-5111	6 ft	40W	No	4800 lm	1800 mm
FBAT6HOCC	2756-5117	6 ft	67W	No	8040 lm	1800 mm
<b>3 hr Maintained Emergency</b>						
FBAT4CCE3	2756-5072	4 ft	20W	No	2400 lm	1200 mm
FBAT4HOCCCE3	2756-5078	4 ft	40W	No	4800 lm	1200 mm
FBAT5CCE3	2756-5087	5 ft	30W	No	3600 lm	1500 mm
FBAT5CCSE3	2756-5096	5 ft	30W	Microwave	3600 lm	1500 mm
FBAT5HOCCCE3	2756-5102	5 ft	60W	No	7200 lm	1500 mm
FBAT5HOCCSE3	2756-5108	5 ft	60W	Microwave	7200 lm	1500 mm
FBAT6CCE3	2756-5114	6 ft	40W	No	4800 lm	1800 mm
FBAT6HOCCCE3	2756-5120	6 ft	67W	No	8040 lm	1800 mm

**Microwave features:**

- Detection angle [ceiling]: 360°  
[wall]: 150°
- Detection range: 10 m
- Timer adjustment: 5 secs, 30 secs, 90 secs, 5 mins, 20 mins or 30 mins



Visit [cef.co.uk](http://cef.co.uk) for video demonstration

## LED NON-CORROSIVE FITTINGS

### LED Non-Corrosive Fittings IP65

Fusion Ref	Code	Size	Wattage	Lumens	Length	Width	Depth
<b>Standard</b>							
FNCF2	2613-7831	2 ft	9W	1100 lm	600 mm	96 mm	79 mm
FNCF2HO	2613-7834	2 ft	18W	2200 lm	600 mm	96 mm	79 mm
FNCF4	2613-7894	4 ft	18W	2200 lm	1200 mm	96 mm	79 mm
FNCF4HO	2613-7840	4 ft	40W	4800 lm	1200 mm	96 mm	79 mm
FNCF5	2613-7846	5 ft	23W	2800 lm	1500 mm	96 mm	79 mm
FNCF5HO	2613-7852	5 ft	48W	5800 lm	1500 mm	96 mm	79 mm
FNCF6	2613-7858	6 ft	27W	3200 lm	1800 mm	96 mm	83 mm
FNCF6HO	2613-7864	6 ft	55W	6600 lm	1800 mm	96 mm	83 mm
<b>Standard - Microwave Sensor</b>							
FNCF5S	2726-9278	5 ft	23W	2800 lm	1500 mm	96 mm	79 mm
FNCF5HOS	2726-9272	5 ft	48W	5800 lm	1500 mm	96 mm	79 mm
<b>3 hr Maintained Emergency</b>							
FNCF4E3	2613-7837	4 ft	18W	2200 lm	1200 mm	96 mm	79 mm
FNCF4HOE3	2613-7843	4 ft	40W	4800 lm	1200 mm	96 mm	79 mm
FNCF5E3	2613-7849	5 ft	23W	2800 lm	1500 mm	96 mm	79 mm
FNCF5HOE3	2613-7855	5 ft	48W	5800 lm	1500 mm	96 mm	79 mm
FNCF6E3	2613-7861	6 ft	27W	3200 lm	1800 mm	96 mm	83 mm
FNCF6HOE3	2613-7867	6 ft	55W	6600 lm	1800 mm	96 mm	83 mm
<b>3 hr Maintained Emergency - Microwave Sensor</b>							
FNCF5SE3	2726-9281	5 ft	23W	2800 lm	1500 mm	96 mm	79 mm
FNCF5HOSE3	2726-9275	5 ft	48W	5800 lm	1500 mm	96 mm	79 mm



- Polycarbonate body and purpose-designed opal diffuser
- Colour temperature: Cool white 4000K
- Lamp life: 50,000 hrs
- Impact rating: IK08
- Mounted: Surface or suspended
- Warranty: 5 Years [on-site: 1 year]
- Emergency Warranty: 2 Years

**Microwave features:**

- Detection angle [ceiling]: 360°  
[wall]: 150°
- Detection range: 10 m
- Timer adjustment: 5 secs, 30 secs, 90 secs, 5 mins, 20 mins or 30 mins

**Includes:**

- Stainless steel fixing clips
- Gear tray extension cords



Visit [cef.co.uk](http://cef.co.uk) for video demonstration



## LED LINEAR SURFACE FITTINGS

### Vapour Proof LED Linear Fittings IP65



- Slimline design
- Extruded single piece polycarbonate body and diffuser
- Stainless steel mounting brackets supplied
- Quick-fit terminal with gland
- Beam angle: 120°
- Warranty: 2 Years



Fusion Ref	Code	Size	Wattage	Lumens	Length
FVP4FT	2607-5575	4 ft	36W	3600 lm	1261 mm
FVP5FT	2607-5578	5 ft	45W	4500 lm	1541 mm
FVP6FT	2607-5581	6 ft	60W	6000 lm	1841 mm

### Aten LED Linear Fittings IP20



- Glass-free lighting solution ideal for kitchens
- Powder-coated aluminium body with PMMA opal diffuser and polycarbonate end caps
- Colour temperature: Cool white 4000K
- Lamp life: 30,000 hrs
- Dimensions: 133 mm[W] x 45 mm[D]
- Mounted: Surface
- Warranty: 2 Years



Fusion Ref	Code	Size	Wattage	Lumens	Length
DLLEDSM600	1994-9083	2 ft	25W	2000 lm	594 mm
DLLEDSM1200	1994-9077	4 ft	48W	4300 lm	1194 mm
DLLEDSM1500	1994-9080	5 ft	48W	4800 lm	1494 mm

## LED SCHOOL BATTENS

### LED CCT & Wattage Selectable School Battens IP20

- Polycarbonate UV stabilised diffuser
- Steel body with powder coated finish
- Wattage selectable [see table]
- CCT colour selectable function: [3000K / 4000K / 6500K]
- Up to 8400 Lumens
- Plug-and-play component arrangement for ease of maintenance
- Hinged diffuser cover with locking catch
- Push-fit [loop-in/loop-out] terminal block
- LED Lifetime: 50,000hrs [L70/B50]
- Optional Plug & Play 3 Hour Emergency Pack: FSBATE3
- Optional Plug & Play Microwave Sensor Pack: FSBATSEN
- Warranty: 5 Years [on-site: 1 year]
- Emergency Warranty: 2 Years



Fusion Ref	Code	Wattage Selectable	Description	Length
FSBAT4CCW	2905-9099	20/27/34/40W	School Batten 4ft Wattage & CCT Selectable c/w Opal Diffuser	1200 mm
FSBAT5CCW	2905-9102	35/47/58/70W	School Batten 5ft Wattage & CCT Selectable c/w Opal Diffuser	1500 mm
FSBATE3	2905-9105	-	School Batten 3 Hour Emergency Pack	218 mm
FSBATSEN	2905-9108	-	School Batten On-Off Microwave Sensor	104 mm

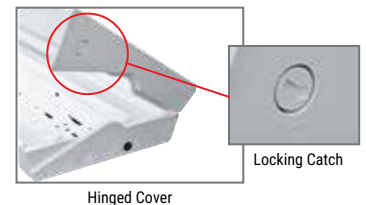

## LED PANELS

### 30W Backlit TP[b] 600 x 600 LED Panel IP20

- Aluminium body with low glare opal polycarbonate diffuser
- Stepped frame for flush ceiling grid mounting
- Optional emergency conversion pack - sold separately [2628-3835]
- Non-dimmable
- Lumen output: 3,150 lm
- Lamp life: 50,000 hrs
- Mounted: Recessed
- Warranty: 5 Years [on-site: 1 year]
- Emergency Warranty: 2 Years

Includes:  
▪ Plug-and-play driver

Fusion Ref	Code	Length	Width	Depth
<b>Cool White - 4000K</b>				
FP66/CW	2831-3992	595 mm	595 mm	34 mm



## LED PANELS

### 40W LED 600 x 600 Panel Frame IP20



- Uniform light distribution
- Lumen output: 4000 lm
- Lamp life: 25,000 hrs
- Mounted: Recessed
- Optional emergency pack available
- Warranty: 5 Years [on-site: 1 year]
- Emergency Warranty: 2 Years



- Includes:
- Plug-and-play driver
  - Push-fit loop in / out terminal block

Fusion Ref	Code	Length	Width	Depth
<b>Cool White - 4000K</b>				
FPF66CW	2789-8966	595 mm	595 mm	13.5 mm

### Backlit TP[a] 600 x 600 Tri-Colour LED Panel IP20



- Aluminium body with low glare opal polycarbonate diffuser
- Stepped frame for flush ceiling grid mounting
- Selectable colour temperature: Warm white 3000K, cool white 4000K and daylight 6500K
- Optional emergency conversion pack - sold separately [2628-3835]
- Non-dimmable
- Lumen output: 3,600 lm
- Lamp life: 50,000 hrs
- Mounted: Recessed
- Warranty: 5 Years [on-site: 1 year]
- Emergency Warranty: 2 Years



- Includes:
- Plug-and-play driver
  - Push-fit loop in / out terminal block

Fusion Ref	Code	Wattage	Length	Width	Depth
FP66/CC	2831-3989	36W	595 mm	595 mm	34 mm
FP123/CC	2897-9473	36W	1195 mm	295 mm	34 mm
FP126/CC	2897-9476	45W	1195 mm	595 mm	34 mm

### Surface Frames for LED Panels



- Surface mounting frames suitable for use with Fusion LED panels
- This product comes unassembled



Fusion Ref	Code	Length	Width	Depth
FPSF66	2822-6845	595 mm	595 mm	70 mm
FPSF123	2822-6833	1195 mm	295 mm	70 mm
FPSF126	2822-6842	1195 mm	595 mm	70 mm

## LED EMERGENCY PACKS



### 4.3W Maintained Emergency Conversion Pack IP20

- Designed for Fusion LED panels
- LiFePO4 battery technology greatly improves operational life and charging cycle capacity
- Emergency duration: 3 hrs
- 24 Hour charge time
- Charge indicator LED
- Test button
- Emergency duration: 3 hrs
- Warranty: 2 Years



Fusion Ref	Code	Length	Width	Depth
FE3P	2628-3835	213 mm	95 mm	40 mm

### Dimmable Panel Drivers



- Suitable for use with Fusion LED panels
- 40W constant current LED driver
- Class II, SELV, independent
- Input voltage 220-240VAC
- Protections: SCP/OLP/OVP
- Power Factor 0.95±0.05
- Efficiency ≥87%
- Support Leading edge and trailing edge dimmable
- Warranty: 5 Years



Fusion Ref	Code	Length	Width	Depth
FP66TDD	2744-4985	150 mm	44 mm	30 mm
FP126TDD	2744-4979	150 mm	44 mm	30 mm
FPDDALI/10	2789-8960	105 mm	69 mm	28 mm

## LED COMMERCIAL DOWNLIGHTS

### LED CCT Low Profile Commercial Downlights IP20



- White body with opal polycarbonate diffuser
- Ideal replacement for existing CFL fixtures
- Mounted: Recessed
- Lamp life: 25,000 hrs
- Warranty: 2 Years



- Includes:
- Plug-and-play driver

Fusion Ref	Code	Wattage	Lumens	Depth	Ø	Cut Out Ø
FCD6CC	2861-7577	6W	500 lm	27 mm	128 mm	115mm
FCD12CC	2861-7568	12W	1200 lm	27 mm	170 mm	155 mm
FCD18CC	2861-7571	18W	1850 lm	27 mm	229 mm	210 mm
FCD24CC	2861-7574	24W	2500 lm	27 mm	298 mm	280 mm

### LED Flexi-Fit Tri-Colour Downlights IP20

- White body with opal polycarbonate diffuser
- Integrated switch to select colour temperatures
- Adjustable spring clips allow recessed mounting in downlight holes
- Selectable colour temperature: Warm white 3000K, cool white 4000K and daylight 6000K
- Interchangeable magnetic bezels available - sold separately
- Mounted: Surface or recessed
- Lamp life: 30,000 hrs
- Warranty: 2 Years

- Includes:
- Integrated driver



#### 6W Downlight

- Lumen output: 390, 420 or 450 lm

Fusion Ref	Code	Depth	Ø	Cut Out Ø
FFF6CC	2606-9203	15 mm	140 mm	55 - 100 mm
Fusion Ref	Code	Finish		
Magnetic Bezel				
FFFB6CH	2606-9218	Chrome		
FFFB6B	2606-9215	Matt Black		
FFFB6SN	2606-9221	Satin Nickel		

#### 18W Downlight

- Lumen output: 1,500, 1,530, or 1,560 lm

Fusion Ref	Code	Depth	Ø	Cut Out Ø
FFF18CC	2604-0979	15 mm	217 mm	55 - 175 mm
Fusion Ref	Code	Finish		
Magnetic Bezel				
FFFB18CH	2606-9285	Chrome		
FFFB18B	2606-0982	Matt Black		
FFFB18SN	2606-0988	Satin Nickel		

### 4.1W Emergency Pack Conversion Kit IP20



- Emergency conversion kit for LED circular downlights from Fusion Luminaires
- Manual test button
- Plug and play connections
- Maintained Emergency [3hrs/180mins]



Fusion Ref	Code	Description
FE3CD	2634-4570	4.1W Maintained Emergency Conversion Pack for LED Circular Downlights

### 2W Maintained Emergency Conversion Pack



- Emergency conversion kit for LED Flexi-Fit downlight from Fusion Luminaires
- Manual test button
- Plug and play connections
- Maintained Emergency [3hrs/180mins]



Fusion Ref	Code	Description
FE3FF	2756-5060	4.1W Maintained Emergency Conversion Pack for LED Flexifit Downlights



Visit [cef.co.uk](http://cef.co.uk) for video demonstration

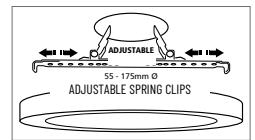

#### 12W Downlight

- Lumen output: 900, 930 or 960 lm

Fusion Ref	Code	Depth	Ø	Cut Out Ø
FFF12CC	2827-5349	15 mm	165 mm	55 - 125 mm
Fusion Ref	Code	Finish		
Magnetic Bezel				
FFFB12CH	2827-5343	Chrome		
FFFB12B	2827-5340	Matt Black		
FFFB12SN	2827-5346	Satin Nickel		

#### 24W Downlight

- Lumen output: 1,980, 2,010 or 2,040 lm

Fusion Ref	Code	Depth	Ø	Cut Out Ø
FFF24CC	2606-9200	15 mm	290 mm	60 - 250 mm
Fusion Ref	Code	Finish		
Magnetic Bezel				
FFFB24CH	2606-9209	Chrome		
FFFB24B	2606-9206	Matt Black		
FFFB24SN	2606-9212	Satin Nickel		

## LED COMMERCIAL DOWNLIGHTS

### 5.5W / 7.5W LED Fire Rated Tri-Colour Downlights IP65

- Range: LED FRD
- Selectable colour temperature: Warm white 3000K, cool white 4000K and daylight 6500K
- Colour selectable via switch located underneath the bezel
- Lumen output [5.5W]: 500 lm / 550 lm  
[7.5W]: 600 lm / 650 lm
- Integral driver and separate prewired loop in / out plug-and-play connector
- Dimmable
- Fire rated: 30, 60 and 90 mins
- Lamp life: 25,000 hrs
- Warranty: 3 Years



Fusion Ref	Code	Finish	Beam Angle	Depth	∅	Cut Out ∅
<b>Bezel Included - Pack of 1</b>						
FFRDCCW	2831-3983	White	60°	55 mm	87 mm	70 - 75 mm
Fusion Ref	Code	Beam Angle	Depth	∅	Cut Out ∅	
<b>Bezel Not Included - Pack of 10</b>						
FFRDCCW/10PK	2831-3986	60°	55 mm	87 mm	70 - 75 mm	
Fusion Ref	Code	Finish	Fusion Ref	Code	Finish	
<b>Plastic Bezels</b>			<b>Metal Bezels</b>			
FFRDDBA	2684-2333	Anthracite	FFRDMBA	2743-9093	Anthracite	
FFRDBBB	2628-8347	Matt Black	FFRDMBB	2743-9096	Matt Black	
FFRDBCH	2628-8350	Chrome	FFRDMBCH	2743-9099	Chrome	
FFRDBPB	2684-2336	Polished Brass	FFRDMBPB	2743-9102	Polished Brass	
FFRDBSN	2628-8353	Satin Nickel	FFRDMBSN	2743-9105	Satin Nickel	
FFRDBWH	2628-8356	White	FFRDMBWH	2743-9108	White	



### GU10 Fire Rated Downlight Canister

- Fire rated LED GU10 fitting only [no bezel]
- Designed for standard height GU10 LED lamps [sold separately]
- 30, 60 and 90 minute fire rating
- Part B, C and E compliant
- Insulation coverable
- Push-fit [loop-in/loop-out] terminal block
- Twist and lock aluminium bezels available in white, chrome, satin nickel and black [sold separately]
- IP20/IP65 when bezel is fitted
- Warranty: 2 Years

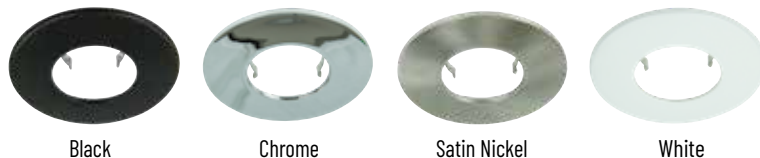

Fusion Ref	Code	Finish	Height	∅	Cut Out ∅
FFRD/CAN	2824-3156	Black	81 mm	81 mm	72 mm
Fusion Ref	Code	Finish	Fusion Ref	Code	Finish
<b>Bezels IP20</b>			<b>Bezels IP65</b>		
FFRD/D/BLK	2824-3162	Black	FFRD/IP65/BLK	2824-3174	Black
FFRD/D/CH	2824-3165	Chrome	FFRD/IP65/CH	2824-3177	Chrome
FFRD/D/SN	2824-3168	Satin Nickel	FFRD/IP65/SN	2824-3180	Satin Nickel
FFRD/D/WH	2824-3171	White	FFRD/IP65/WH	2824-3183	White

See Page 20 for full range of GU10 Lamps

## UNDER CABINET LIGHTS

### LED Slimline Colour Selectable Under Cabinet Lights IP20



- Suitable replacement for traditional T4 and T5 fluorescent fittings
- Compact, surface mounted design
- Selectable colour temperature: Warm white 3000K and cool white 4000K
- Beam angle: 150°
- Lamp life: 30,000 hrs
- Warranty: 3 Years



Includes:

- 1.5 m Mains cable
- 170 mm Link cable
- Fixing brackets
- Connector



Fusion Ref	Code	Wattage	Length	Lumens
FLL4CC225	2795-8372	4W	225 mm	400 lm
FLL4CC	2795-8369	4W	288 mm	450 lm
FLL7CC	2795-8378	7W	516 mm	850 lm
FLL13CC	2795-8360	13W	849 mm	1500 lm
FLL18CC	2795-8363	18W	1149 mm	1800 lm

### Under Cabinet Link Leads



- Link Lead for Under Cabinet Link Lights



Fusion Ref	Code	Length
FLL250MM	2795-8366	250 mm
FLL500MM	2795-8375	500 mm
FLL1000MM	2795-8357	1000 mm

## SHAVER LIGHTS

### 6W Dual Voltage Shaver Light IP20



- Not for use in zoned areas
- White fitting with prismatic diffuser and dual voltage shaver socket
- Voltage rating: 110V and 230V
- Pullcord On / Off switch
- Lamp type: 6W LED Striplight [284 mm][included]
- Lumen output: 550 lm
- Lamp life: 20,000 hrs
- Warranty: 1 Year



Fusion Ref	Code	Length	Height	Depth
FSL	2745-4762	495 mm	60 mm	70 mm

# Easy ways to pay

Cash, card or trade account

## LED HIGH BAY FITTINGS

### LED Tri-Colour Highbay Fittings IP65

- Ideal for replacement of SON or metal halide high bays
- Die-cast aluminium housing with integral driver and polycarbonate lens
- Wattage selectable on-site for improved energy savings
- 1 - 10V Dimmable as standard
- Beam angle: 120°
- Selectable colour temperature: Warm white 3000K, cool white 4000K and daylight 5000K
- Lamp life: 50,000 hrs
- Warranty: 5 Years [on-site: 1 year] [emergency: 2 years]

Microwave features:

- Detection angle: 360°
- Detection range: 12 m
- Timer adjustment: 5 secs, 30 secs, 1 min, 3 mins, 5 mins, 10 mins, 20 mins or 30 mins

Includes:

- 1.3 m Cable [standard]
- 0.5 m Cable [3 hr maintained emergency]



Fusion Ref	Code	Wattage	Lumens	Depth	Ø
<b>Standard</b>					
FHBCCTSM	2831-6815	80W / 120W / 150W	11800 - 21000 lm	125 mm	280 mm
FHBCCTLRG	2831-6812	150W / 200W / 240W	21400 - 34150 lm	125 mm	320 mm
<b>3 hr Maintained Emergency</b>					
FHBCCTSM/E3	2811-2527	80W / 120W / 150W	11800 - 21000 lm	340 mm	285 mm
Fusion Ref	Code	Suitable For	Beam Angle		
<b>Aluminium Reflector</b>					
FHBAR90/SML	2821-9414	80W / 120W / 150W	90°		
FHBAR90/LRG	2821-9411	150W / 200W / 240W	90°		
<b>Polycarbonate Reflector</b>					
FHBPR90/SML	2831-6821	80W / 120W / 150W	90°		
FHBPR90/LRG	2831-6818	150W / 200W / 240W	90°		
Fusion Ref	Code	Description			
FHBBKT	2821-9417	Mounting Bracket - Standard Versions Only			
FHBSEN	2831-6824	Dimmable Microwave Sensor			
FHBR	2604-1012	Remote Control for Microwave Sensor			



Aluminium Reflector



Polycarbonate Reflector



Remote Control

## LED EMERGENCY LIGHTING

### 2.7W LED Maintained / Non-Maintained Emergency Droplights IP20

- Multiple mounting options offer complete versatility
- Polycarbonate housing
- Test button and charge indicator LED
- Emergency duration: 3 hrs
- Emergency lumen output: 14 lm
- Lumen output: 23 lm
- Lamp life: 30,000 hrs
- Mounted: Ceiling suspended, recessed, side or wall [fixing kit included]
- Warranty: 2 Years



Fusion Ref	Code	Type	Legend	Height	Width	Depth
FE3/5IN1	2658-8812	Standard	Exit Arrow Up	180 mm	264 mm	28 mm
FE3/5IN1/ST	2743-9399	Auto Self-Test	Exit Arrow Up	180 mm	264 mm	28 mm

ISO 7010 Legends available - ask in-branch for details



Visit [cef.co.uk](http://cef.co.uk) for video demonstration

## LED EMERGENCY LIGHTING

### LED Emergency Bulkheads IP65



- High quality polycarbonate body and diffuser with hinged gear tray
  - LiFePO4 battery technology greatly improves operational life and charging cycle capacity
  - Emergency duration: 3 hrs
  - Colour temperature: Daylight 6500K
  - Emergency lumen output: 110 lm
  - Lumen output: 170 lm
  - Lamp life: 30,000 hrs
  - Mounted: Surface or recessed using bezel [2822-8885]
  - Warranty: 2 Years
- Includes:
- ISO 7010 Legend pack



Fusion Ref	Code	Wattage	Type	Emergency Type	Height	Width	Depth
FE3BNM	2816-1985	1.1W	Standard	Non-Maintained	107 mm	349 mm	64 mm
FE3BM	2816-1979	2.3W	Standard	Maintained / Non-Maintained	107 mm	349 mm	64 mm
FE3BM/ST	2816-1982	2.3W	Auto Self-Test	Maintained / Non-Maintained	107 mm	349 mm	64 mm

Fusion Ref	Code	Description
FE3B/RB	2822-8885	Recessed Mounting Bezel

### 3W LED Non-Maintained Emergency Twinspots IP65



- Polycarbonate construction
- LiFePO4 battery technology greatly improves operational life and charging cycle capacity
- Emergency duration: 3 hrs
- Colour temperature: Daylight 6500K
- Lumen output: 297 lm
- Lamp life: 30,000 hrs
- Warranty: 2 Years



Fusion Ref	Code	Type	Height	Width	Depth
FE3TS	2658-8821	Standard	281 mm	297 mm	89 mm
FE3TS/ST	2743-9411	Auto Self-Test	281 mm	297 mm	89 mm

### 3.5W LED Maintained / Non-Maintained Emergency Exit Boxes IP20



- Polycarbonate housing and diffuser
- LiFePO4 battery technology greatly improves operational life and charging cycle capacity
- Emergency duration: 3 hrs
- Colour temperature: Daylight 6500K
- Emergency lumen output: 20 lm
- Lumen output: 35 lm
- Lamp life: 30,000 hrs
- Legend: Exit Arrow Up
- Warranty: 2 Years



Fusion Ref	Code	Type	Height	Width	Depth
FE3EB	2745-0358	Standard	185 mm	330 mm	39 mm
FE3EB/ST	2743-9405	Auto Self-Test	185 mm	330 mm	39 mm

ISO 7010 Legends available - ask in-branch for details

### 1W LED Non-Maintained Emergency Downlights IP20



- Interchangeable lenses available to suit specific settings - sold separately
- LiFePO4 battery technology greatly improves operational life and charging cycle capacity
- Emergency duration: 3 hrs
- Colour temperature: Daylight 6500K
- Lumen output: 121 lm
- Lamp life: 30,000 hrs
- Mounted: Recessed
- Warranty: 2 Years



Visit [cef.co.uk](http://cef.co.uk) for video demonstration

- Includes:
- Battery pack and driver

Fusion Ref	Code	Type	Beam Angle	Depth	Ø	Cut Out Ø
FE3D1	2628-8332	Standard	120°	50 mm	50 mm	45 mm
FE3D1/ST	2743-9402	Auto Self-Test	120°	50 mm	50 mm	45 mm

Fusion Ref	Code	Type	Beam Angle	Depth	Ø
<b>Accessories</b>					
FE3D1CL	2628-8335	Corridor Lens	170°	10 mm	33 mm
FE3D1NSL	2628-8338	Narrow Spot Lens	45°	13 mm	33 mm

## CONTEMPORARY UP / DOWNLIGHTS

### GU10 Up / Downlights IP44 - Black

- Black aluminium up / downlight
  - Lamp type: GU10 LED [not included]
  - Max. Lamp wattage: 35W
  - Warranty: 1 Year
- PIR Features:
    - Detection range: 6 m
    - Timer adjustment: 8 secs - 5 mins

Fusion Ref	Code	Description	Height	Width	Projection
<b>Standard</b>					
FWLDB	2704-3162	Downlight	123 mm	86 mm	92 mm
FWLUDB	2704-4374	Up / Downlight	164 mm	86 mm	92 mm
<b>Photocell</b>					
FWLUDBPC	2754-6328	Up / Downlight	222 mm	69 mm	106 mm
<b>PIR</b>					
FWLUDBPIR	2704-4377	Up / Downlight	222 mm	69 mm	106 mm



### GU10 Up / Downlights IP44 - Stainless Steel

- Stainless steel up / downlight
  - Lamp type: GU10 [not included]
  - Max. Lamp wattage: 35W
  - Warranty: 1 Year
- PIR Features:
    - Detection range: 6 m
    - Timer adjustment: 8 secs - 5 mins

Fusion Ref	Code	Description	Height	Width	Projection
<b>Standard</b>					
FWLDSS	2704-3165	Downlight	123 mm	86 mm	92 mm
FWLUDSS	2704-4380	Up / Downlight	164 mm	86 mm	92 mm
<b>Photocell</b>					
FWLUDSSPC	2754-6331	Up / Downlight	222 mm	69 mm	106 mm
<b>PIR</b>					
FWLUDSSPIR	2704-4386	Up / Downlight	222 mm	69 mm	106 mm

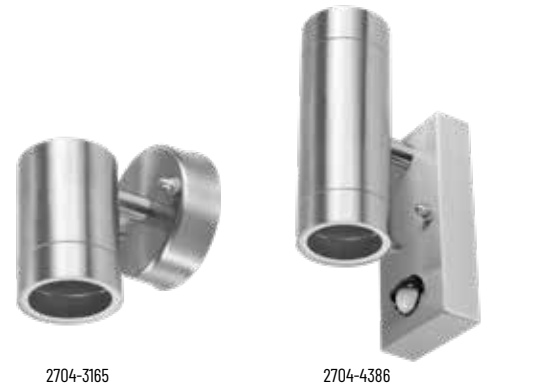

## SPIKE LIGHTS

### Spike Lights IP65

- Adjustable spike light
- Lamp type: GU10 [not included]
- Max. Lamp wattage: 35W
- Warranty: 1 Year



Fusion Ref	Code	Finish	Height	Ø
FGSB	2704-3153	Black	263 mm	63.5 mm
FGSBG2	2704-3156	Black	315 mm	98 mm
FGSSS	2704-3159	Stainless Steel	273 mm	60 mm

See Page 20 for full range of GU10 Lamps



## LED STRIP KITS

### 24W Plug-In LED Strip Light Kits IP65 - 5 m

- Flexible 8 mm self-adhesive strip
- Can be cut at 50 mm intervals to allow for corners
- Lamp life: 30,000 hrs
- Warranty: 2 Years

Kit contents:

- 12V Plug-in driver

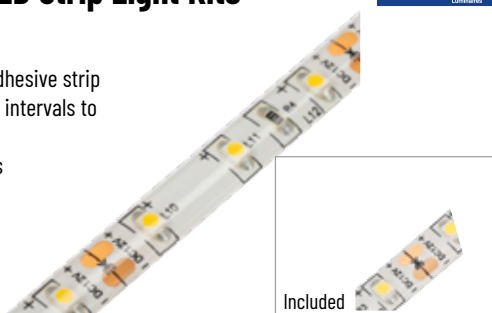

Fusion Ref	Code	Colour
LEDSTRIPWWBP	2384-6476	Warm White - 3000K
LEDSTRIPCWBP	2384-6470	Cool White - 4000K
LEDSTRIPDWPB	2752-2955	Daylight - 4000K

### 36W Plug-In RGB Colour Changing LED Strip Light Kit IP65 - 5 m

- Flexible 10 mm self-adhesive strip
- Can be cut at 100 mm intervals to allow for corners
- Lamp life: 30,000 hrs
- Warranty: 2 Years

Kit contents:

- Remote control
- Receiver
- 12V Plug-in driver



Fusion Ref	Code
LEDSTRIPRGBBP	2384-6473

## PHOTOCELLS

### 10A Wall Mounted Electronic Photocell Kit IP65

- Ideal for controlling external lighting circuits
- Photodiode sensor with opal diffuser
- Lux levels: 10 - 16 / 65 lx
- Warranty: 1 Year

Kit contents:

- Photocell head
- Base holder
- Bracket
- NEMA Socket
- Integral gasket
- Screws and wall plugs

Load rating:

- Max. 2,000W [10A] Incandescent lamps
- Max. 600W [2A] LED Lamp

Fusion Ref	Code	Description	Height	Projection
DL4061	0337-5454	Kit	133 mm	87 mm
DL4050	0337-5451	Replacement Head	60 mm	-

### Miniature Electronic Photocell IP65

- Photodiode sensor
- Suitable for use in external fixtures
- VDR Voltage suppression
- Fits into 20 mm[Ø] cut out
- Maximum capacity: 60µF
- Lux levels: 70 / 105 lx
- Switching delay: 10 - 30 secs
- Warranty: 1 Year

Load rating:

- Max. 1,200W [5A] Incandescent lamps
- Max. 250W [1A] LED Lamps

Fusion Ref	Code	Length	Width	Depth
SS14	2236-3081	54 mm	36 mm	39 mm

### Miniature Thermal Nipple Head Photocell IP65

- Thermal nipple head with photodiode sensor
- Suitable for use in external fixtures
- Fits into 20 mm[Ø] cut out
- Lux levels: 10 - 16 / 65 lx
- Warranty: 1 Year

Load rating:

- Max. 2,000W [8A] Incandescent lamps
- Max. 200W [0.8A] LED Lamps

Fusion Ref	Code	Length	Width	Depth
DLNPC	0337-5469	50 mm	28 mm	40 mm

## PHOTOCELLS

### Wall Mounted Electronic Photocell Kit IP65

- UV Stabilised polycarbonate
- Electromagnetic Relay switch
- Lux levels [5A]: 70 / 105 lx [1:1.5 + VE]  
[10A]: 70 / 35 lx [1:0.5 + VE]
- Switching delay: 15 secs
- Warranty: 1 Year

Kit contents:

- Photocell head
- Base holder
- Bracket
- NEMA Socket
- Integral gasket
- Screws and wall plugs



Fusion Ref	Code	Description	Height	Projection
<b>Opal Diffuser - 5A</b>				
3061	0003-7102	Kit	124 mm	87 mm
3050	0003-7096	Replacement Head	50 mm	-

## LOW VOLTAGE DIMMABLE TRANSFORMERS

### Low Voltage Electronic Dimmable Transformers



- For use with low voltage [12V] lamps
- Soft start feature extends lamp life
- Auto-resetting overload and overheat protection
- EN 61347
- Warranty: 1 Year

Fusion Ref	Code	Power Range	Length	Width	Depth
YT50	0942-1825	0 - 50W	95 mm	27.5 mm	41.5 mm
YT105	0052-1065	0 - 105W	108 mm	33 mm	44 mm
YT150	0052-1068	0 - 150W	167 mm	38.5 mm	52.5 mm
YT210	2035-5055	0 - 210W	167 mm	38.5 mm	52.5 mm



0052-1065

## DOWNLIGHT LAMP HOLDERS

### Spare Lampholders

- Designed for use with GU10 or GU5.3 MR16 lamps
- Warranty: 1 Year



2571-3559

0003-9928

Fusion Ref	Code	Cap	Description
CTSLH	0003-9928	GU5.3	Low Voltage [Prewired 145 mm Leads]
CTSLHGU10	0052-0588	GU10	Mains [Prewired 145 mm Leads]
CTSLHGU10S	2571-3559	GU10	Mains [Prewired 240 mm Silicone Cable]

## DOWNLIGHT RETAINING CLIP

### Metal Lamp Retaining Clip



- Metal lamp clip for 50mm MR16 or GU10 lamps
- Suitable for downlight fittings



Fusion Ref	Code	Lamp Ø	Cap
CTSLC	0003-9925	50 mm	MR16 / GU10

# What you need, at speed

Over 44,000 products delivered where and when you need them



### Same-day delivery

If we've got what you need at your local branch, **we can deliver it to you at home, office or on-site.**



### Next-day delivery\*

Order online Monday - Friday and we'll deliver the next working day. **Free delivery on all orders over £50.**



### Click & Collect

Order any product from our website and it will be ready to **collect from your chosen branch the next working day.**

\*Geographical restrictions may apply

# Sustainable Electrical Waste Recycling

**waste  
experts**  
flexible - reliable - responsible

## Protecting our future, together

CEF are the **only electrical distributor in the UK** with an in-house electrical waste recycling facility, offering a complete one-stop recycling service and ensuring compliance with all current legislation.

### Did you know?

- We recycle **over 1 million lamps** each year.
- We recycle **more electrical waste** than any other UK distributor.
- **98%** of the electrical waste we receive is recycled.
- Our nationwide network of **over 390 branches** provides convenient service.



Visit [wasteexperts.co.uk](https://wasteexperts.co.uk)  
for more information

## LED LAMPS

### LED T8 Glass Tubes



- Suitable replacement for fluorescent tubes
- Complete with LED starter for use in switch start retrofit installations
- Beam angle: 300°
- Lamp life: 25,000 hrs
- Guarantee: 3 Years

Fusion Ref	Code	Length	Wattage	Lumens
<b>Non-Dimmable - Cool White - 4000K</b>				
EDLEDTUBE/G2FT	2096-0905	2 ft	9W	1080 lm
EDLEDTUBE/G3FT	2096-0911	2 ft	14W	1680 lm
EDLEDTUBE/G4FT	2096-0923	4 ft	18W	2160 lm
EDLEDTUBE/G5FT	2096-0932	5 ft	24W	2880 lm
EDLEDTUBE/G6FT/24W	2096-0938	6 ft	24W	3600 lm
EDLEDTUBE/8FT/CW	1953-4204	8 ft	36W	3600 lm



### LED T8 Tri-Colour Glass Tubes



- Suitable replacement for fluorescent tubes
- Complete with LED starter for use in switch start retrofit installations
- Selectable colour temperature: Warm white 3000K, cool white 4000K and daylight 6500K
- Beam angle: 300°
- Lamp life: 25,000 hrs
- Guarantee: 3 Years

Fusion Ref	Code	Length	Wattage	Lumens
<b>Non-Dimmable</b>				
EDLEDTUBE/G2FT/CC	2772-8017	2 ft	9W	945 lm / 1080 lm / 990 lm
EDLEDTUBE/G3FT/CC	2772-8020	3 ft	14W	1540 lm / 1680 lm / 1680 lm
EDLEDTUBE/G4FT/CC	2772-8023	4 ft	18W	1980 lm / 2160 lm / 2160 lm
EDLEDTUBE/G5FT/CC	2772-8026	5 ft	24W	2640 lm / 2880 lm / 2880 lm
EDLEDTUBE/G6FT/CC/24W	2772-8029	6 ft	24W	3300 lm / 3600 lm / 3600 lm



### LED T5 Glass Tubes



- Suitable replacement for fluorescent tubes
- Beam angle: 200°
- Lamp life: 25,000 hrs
- Guarantee: 3 Years

Fusion Ref	Code	Length	Wattage	Lumens
<b>Non-Dimmable - Cool White - 4000K</b>				
EDLEDTUBET5/8CW	2772-8041	2 ft	8W	880 lm
EDLEDTUBET5/12CW	2772-8032	3 ft	12W	1320 lm
EDLEDTUBET5/16CW	2772-8035	4 ft	16W	1760 lm
EDLEDTUBET5/20CW	2772-8038	5 ft	20W	2200 lm



### LED T5 Tri-Colour Glass Tubes



- Suitable replacement for fluorescent tubes
- Selectable colour temperature: Warm white 3000K, cool white 4000K and daylight 6500K
- Beam angle: 200°
- Lamp life: 25,000 hrs
- Guarantee: 3 Years

Fusion Ref	Code	Length	Wattage	Lumens
<b>Non-Dimmable</b>				
EDLEDTUBET5/8CCT	2834-0626	2 ft	8W	880 lm
EDLEDTUBET5/12CCT	2834-0617	3 ft	12W	1320 lm
EDLEDTUBET5/16CCT	2834-0620	4 ft	16W	1760 lm
EDLEDTUBET5/20CCT	2834-0623	5 ft	20W	2200 lm



## LED LAMPS

### G23 2 Pin LED Single Compact Lamp



- Low power consumption
- Long lamp life
- Low surface temperature
- Not Suitable for emergency lighting
- Suitable replacement for compact fluorescent lamps
- Ideal for use in commercial and retail applications
- Guarantee: 2 Years



Fusion Ref	Code	Wattage	Length	Lumens
<b>Non-Dimmable - Cool White - 4000K</b>				
FPLS3CW/2P	2838-4273	3W	137 mm	370 lm
FPLS4.5CW/2P	2838-4276	4.5W	165 mm	580 lm
FPLS5CW/2P	2838-4279	5W	220 mm	700 lm

### G24D 2 Pin LED Double Compact Lamp



- Low power consumption
- Long lamp life
- Low surface temperature
- Not Suitable for emergency lighting
- Suitable replacement for compact fluorescent lamps
- Ideal for use in commercial and retail applications
- Guarantee: 2 Years



Fusion Ref	Code	Wattage	Length	Lumens
<b>Non-Dimmable - Cool White - 4000K</b>				
FPLD4.5CW/2P	2838-4228	4.5W	116 mm	660 lm
FPLD6CW/2P	2838-4234	6W	148 mm	835 lm
FPLD9CW/2P	2838-4246	9W	171 mm	1300 lm
<b>Non-Dimmable - White - 3500K</b>				
FPLD6W/2P	2838-4240	6W	148 mm	580 lm
FPLD9W/2P	2838-4252	9W	171 mm	1300 lm

### G24Q 4 Pin LED Double Compact Lamp



- Low power consumption
- Long lamp life
- Low surface temperature
- Not Suitable for emergency lighting
- Suitable replacement for compact fluorescent lamps
- Ideal for use in commercial and retail applications
- Guarantee: 2 Years



Fusion Ref	Code	Wattage	Length	Lumens
<b>Non-Dimmable - Cool White - 4000K</b>				
FPLD4.5CW/4P	2838-4231	4.5W	109 mm	660 lm
FPLD6CW/4P	2838-4237	6W	145 mm	835 lm
FPLD9CW/4P	2838-4249	9W	164 mm	1300 lm
<b>Non-Dimmable - White - 3500K</b>				
FPLD6W/4P	2838-4243	6W	145 mm	580 lm
FPLD9W/4P	2838-4255	9W	164 mm	1300 lm

### GX24Q 4 Pin LED Triple Compact Lamp



- Low power consumption
- Long lamp life
- Low surface temperature
- Not Suitable for emergency lighting
- Suitable replacement for compact fluorescent lamps
- Ideal for use in commercial and retail applications
- Guarantee: 2 Years



Fusion Ref	Code	Wattage	Length	Lumens
<b>Non-Dimmable - Cool White - 4000K</b>				
FPLT6CW/4P	2838-4288	6W	118 mm	840 lm
FPLT9CW/4P	2838-4291	9W	138 mm	1260 lm
FPLT10CW/4P	2838-4282	10W	146 mm	1375 lm
FPLT13CW/4P	2838-4285	13W	167 mm	1780 lm

### 2G11 4 Pin LED PLL Lamp



- Low power consumption
- Long lamp life
- Low surface temperature
- Not Suitable for emergency lighting
- Suitable replacement for compact fluorescent lamps
- Ideal for use in commercial and retail applications
- Guarantee: 2 Years



Fusion Ref	Code	Wattage	Length	Lumens
<b>Non-Dimmable - Cool White - 4000K</b>				
FPLL8CW	2838-4270	8W	230 mm	1000 lm
FPLL12CW	2838-4258	12W	325 mm	1475 lm
FPLL18CW	2838-4261	18W	417 mm	2250 lm
FPLL20CW	2838-4264	20W	537 mm	2500 lm
FPLL24CW	2838-4267	24W	537 mm	3200 lm

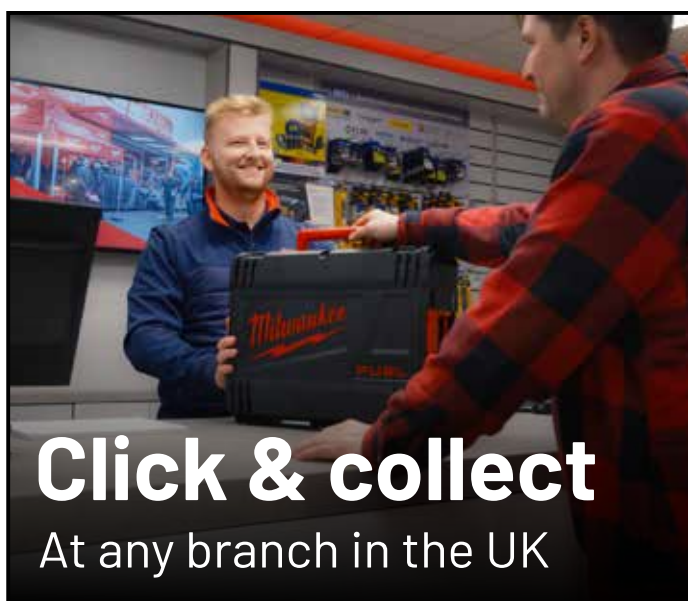

**Click & collect**  
At any branch in the UK

LED LAMPS

GR8 2D 2 Pin LED Lamp

- LED replacement for CFLni - Retrofit & Direct to Mains operation
- Suitable for GR8/ 2pins base with Electromagnetic Ballast [CCG] or AC mains
- Like for like retrofit replacement
- LED Lifetime: 25,000 hours [L70/B50]
- No UV output
- Suggested replacement for 16W & 28W 2D fluorescent lamps
- Guarantee: 3 Years



Fusion Ref	Code	Wattage	Height	Width	Depth	Lumens
Non-Dimmable - Cool White - 4000K						
F2D7CW/2P	2860-8319	7W	135 mm	135 mm	33 mm	750 lm
F2D13CW/2P	2860-8310	13W	200 mm	200 mm	33 mm	1500 lm

GR10q 2D 4 Pin LED Lamp

- LED replacement for CFLni - Retrofit & Direct to Mains operation
- Suitable for GR10q/ 4pins base Direct to AC mains ONLY
- Like for like retrofit replacement
- LED Lifetime: 25,000 hours [L70/B50]
- No UV output
- Suggested replacement for 16W, 28W & 38W 2D fluorescent lamps
- Guarantee: 3 Years



Fusion Ref	Code	Wattage	Height	Width	Depth	Lumens
Non-Dimmable - Cool White - 4000K						
F2D7CW/4P	2860-8319	7W	135 mm	135 mm	33 mm	750 lm
F2D13CW/4P	2860-8313	13W	200 mm	200 mm	33 mm	1500 lm
F2D17CW/4P	2860-8316	17W	200 mm	200 mm	33 mm	1870 lm

8W LED CCT Selectable Gear Tray

- Retro fit/replaceable - fits most existing 2D/LED Bulkheads
- Selectable colour temperature: Warm white 3000K, cool white 4000K and daylight 6500K
- Push-fit [loop-in/loop out] terminal block
- Guarantee: 3 Years



Fusion Ref	Code	Height	∅	Lumens
FGT8	2861-7526	30 mm	190 mm	1050 lm
Emergency				
FGT8E3	2861-7529	30 mm	190 mm	1050 lm

16W LED CCT Selectable Gear Tray

- Retro fit/replaceable - fits most existing 2D/LED Bulkheads
- Selectable colour temperature: Warm white 3000K, cool white 4000K and daylight 6500K
- Push-fit [loop-in/loop out] terminal block
- Guarantee: 3 Years



Fusion Ref	Code	Height	∅	Lumens
FGT16	2861-7514	30 mm	243 mm	2050 lm
Emergency				
FGT16E3	2861-7517	30 mm	243 mm	2050 lm
Sensor				
FGT16S	2861-7520	30 mm	243 mm	2050 lm
Sensor Emergency				
FGT16SE3	2861-7523	30 mm	243 mm	2050 lm

Online & telephone support

01763 272 717 | Mon-Fri 7:30am-8:00pm



## LED LAMPS

### Essential LED GU10 Lamps 230V - Pack of 10



- Suitable replacement for 35W and 50W halogen lamps
- Beam angle: 38°
- Lamp life: 20,000 hrs
- Guarantee: 2 Years

Fusion Ref	Code	Wattage	Lumens	Colour Temp
<b>Non-Dimmable</b>				
FEGU10/2.6/WW/10P	2818-4512	2.6W	257 lm	Warm White - 3000K
FEGU10/2.6/CW/10P	2818-4509	2.6W	257 lm	Cool White - 4000K
FEGU10/3.7/WW/10P	2818-4602	3.7W	352 lm	Warm White - 3000K
FEGU10/3.7/CW/10P	2818-4515	3.7W	352 lm	Cool White - 4000K
FEGU10/3.7/DW/10P	2818-4590	3.7W	352 lm	Daylight - 6000K
<b>Dimmable</b>				
FEGU10/3.7/WW/D/10P	2818-4608	3.7W	352 lm	Warm White - 3000K
FEGU10/3.7/CW/D/10P	2818-4584	3.7W	352 lm	Cool White - 4000K
FEGU10/3.7/DW/D/10P	2818-4596	3.7W	352 lm	Daylight - 6000K



### 3.7W Essential LED GU10 Lamps



- Suitable replacement for 50W halogen lamps
- Beam angle: 38°
- Lamp life: 20,000 hrs
- Guarantee: 2 Years



Fusion Ref	Code	Lumens	Colour Temp
<b>Non-Dimmable</b>			
FEGU10/3.7/WW	2818-4599	352 lm	Warm White - 3000K
FEGU10/3.7/CW	2818-4578	352 lm	Cool White - 4000K
FEGU10/3.7/DW	2818-4587	352 lm	Daylight - 6000K
<b>Dimmable</b>			
FEGU10/3.7/WW/D	2818-4605	352 lm	Warm White - 3000K
FEGU10/3.7/CW/D	2818-4581	352 lm	Cool White - 4000K
FEGU10/3.7/DW/D	2818-4593	352 lm	Daylight - 6000K

### 4.5W LED GU10 Wide Flood Lamps



- Suitable replacement for 50W halogen lamps
- Lamp life: 20,000 hrs
- Guarantee: 2 Years



Fusion Ref	Code	Lumens	Colour Temp
<b>Non-Dimmable</b>			
FEGU10WF/4.5/WW	2834-8312	540 lm	Warm White - 3000K
FEGU10WF/4.5/CW	2835-2746	540 lm	Cool White - 4000K
<b>Dimmable</b>			
FEGU10WF/4.5/WW/D	2838-4225	540 lm	Warm White - 3000K
FEGU10WF/4.5/CW/D	2838-4222	540 lm	Cool White - 4000K

**Free tea, coffee & Wi-Fi**  
When you visit our branches

## LED LAMPS

### 4W Premium LED GLS Lamps



- Suitable replacement for 40W incandescent lamps
- Finish: Opal
- Lamp life: 25,000 hrs
- Guarantee: 3 Years



Fusion Ref	Code	Cap	Lumens
<b>Non-Dimmable - Warm White - 2700K</b>			
F4BC	2818-4965	BC / B22	480 lm
F4ES	2818-4974	ES / E27	480 lm

### 6.75W Premium LED GLS Lamps



- Suitable replacement for 60W incandescent lamps
- Finish: Opal
- Lamp life: 25,000 hrs
- Guarantee: 3 Years



Fusion Ref	Code	Cap	Lumens
<b>Non-Dimmable - Warm White - 2700K</b>			
F6.75BC	2818-4986	BC / B22	810 lm
F6.75ES	2818-4998	ES / E27	810 lm
<b>Dimmable - Warm White - 2700K</b>			
F6.75BC/D	2818-4995	BC / B22	810 lm
F6.75ES/D	2818-5007	ES / E27	810 lm
<b>Non-Dimmable - Cool White - 4000K</b>			
F6.75BC/CW	2818-4989	BC / B22	810 lm
F6.75ES/CW	2818-5001	ES / E27	810 lm
<b>Dimmable - Cool White - 4000K</b>			
F6.75BC/CW/D	2818-4992	BC / B22	810 lm
F6.75ES/CW/D	2818-5004	ES / E27	810 lm

### 8.8W Premium LED GLS Lamps



- Suitable replacement for 75W incandescent lamps
- Finish: Opal
- Lamp life: 25,000 hrs
- Guarantee: 3 Years



Fusion Ref	Code	Cap	Lumens
<b>Non-Dimmable - Warm White - 2700K</b>			
F8.8BC	2818-5010	BC / B22	1056 lm
F8.8ES	2818-5016	ES / E27	1056 lm
<b>Dimmable - Warm White - 2700K</b>			
F8.8BC/D	2818-5013	BC / B22	1056 lm
F8.8ES/D	2818-5019	ES / E27	1056 lm

### 12.7W Premium LED GLS Lamps



- Suitable replacement for a 100W incandescent lamp
- Finish: Opal
- Lamp life: 25,000 hrs
- Guarantee: 3 Years



Fusion Ref	Code	Cap	Lumens
<b>Non-Dimmable - Warm White - 2700K</b>			
F12.7BC	2819-7724	BC / B22	1524 lm
F12.7ES	2819-7730	ES / E27	1524 lm
<b>Dimmable - Warm White - 2700K</b>			
F12.7BC/D	2819-7727	BC / B22	1524 lm
F12.7ES/D	2819-7733	ES / E27	1524 lm

### 4.7W Essential LED GLS Lamps



- Suitable replacement for a 40W incandescent lamp
- Finish: Opal
- Lamp life: 15,000 hrs
- Guarantee: 1 Years



Fusion Ref	Code	Cap	Lumens
<b>Non-Dimmable - Warm White - 2700K</b>			
FE4.7BC	2818-5028	BC / B22	470 lm
FE4.7ES	2818-5037	ES / E27	470 lm
<b>Non-Dimmable - Cool White - 4000K</b>			
FE4.7BC/CW	2816-1880	BC / B22	470 lm
FE4.7ES/CW	2818-5040	ES / E27	470 lm

### 8.1W Essential LED GLS Lamps



- Suitable replacement for 60W incandescent lamps
- Finish: Opal
- Lamp life: 15,000 hrs
- Guarantee: 1 Year



Fusion Ref	Code	Cap	Lumens
<b>Non-Dimmable - Warm White - 2700K</b>			
FE8.1BC	2818-5049	BC / B22	810 lm
FE8.1ES	2818-5055	ES / E27	810 lm
<b>Dimmable - Warm White - 2700K</b>			
FE8.1BC/D	2818-2757	BC / B22	810 lm
FE8.1ES/D	2816-1889	ES / E27	810 lm

**Easy ways to pay**  
Cash, card or trade account



## LED LAMPS

### 4W LED Filament GLS Lamps

- Suitable replacement for 40W filament lamps
- Finish: Clear
- Lamp life: 15,000 hrs
- Guarantee: 2 Years



Fusion Ref	Code	Cap	Lumens
<b>Non-Dimmable - Warm White - 2700K</b>			
FF4BC	2818-5079	BC / B22	480 lm
FF4ES	2818-5085	ES / E27	480 lm
<b>Dimmable - Warm White - 2700K</b>			
FF4BC/D	2818-5082	BC / B22	480 lm
FF4ES/D	2816-1895	ES / E27	480 lm

### 6W LED Filament GLS Lamps

- Suitable replacement for 60W filament lamps
- Finish: Clear
- Lamp life: 15,000 hrs
- Guarantee: 2 Years



Fusion Ref	Code	Cap	Lumens
<b>Non-Dimmable - Warm White - 2700K</b>			
FF6BC	2818-5088	BC / B22	806 lm
FF6ES	2818-5100	ES / E27	806 lm
<b>Dimmable - Warm White - 2700K</b>			
FF6BC/D	2818-5097	BC / B22	806 lm
FF6ES/D	2818-0564	ES / E27	806 lm

### 8W LED Filament GLS Lamps

- Suitable replacement for 75W filament lamps
- Finish: Clear
- Lamp life: 15,000 hrs
- Guarantee: 2 Years



Fusion Ref	Code	Cap	Lumens
<b>Non-Dimmable - Warm White - 2700K</b>			
FF8BC	2818-5106	BC / B22	1055 lm
FF8ES	2818-5112	ES / E27	1055 lm
<b>Dimmable - Warm White - 2700K</b>			
FF8BC/D	2818-5109	BC / B22	1055 lm
FF8ES/D	2818-5115	ES / E27	1055 lm

### 4W Premium LED Candle Lamps

- Suitable replacement for 40W filament lamps
- Finish: Opal
- Lamp life: 25,000 hrs
- Guarantee: 3 Years



Fusion Ref	Code	Cap	Lumens
<b>Non-Dimmable - Warm White - 2700K</b>			
FC4BC	2818-4521	BC / B22	480 lm
FC4ES	2818-4527	ES / E27	480 lm
FC4SBC	2818-4539	SBC / B15	480 lm
FC4SES	2818-4551	SES / E14	480 lm
<b>Non-Dimmable - Cool White - 4000K</b>			
FC4BC/CW	2818-4524	BC / B22	480 lm
FC4ES/CW	2818-4530	ES / E27	480 lm
FC4SBC/CW	2818-4542	SBC / B15	480 lm
FC4SES/CW	2818-4554	SES / E14	480 lm
<b>Dimmable - Warm White - 2700K</b>			
FC4BC/D	2818-2754	BC / B22	480 lm
FC4ES/D	2818-4536	ES / E27	480 lm
FC4SBC/D	2818-4548	SBC / B15	480 lm
FC4SES/D	2818-4560	SES / E14	480 lm
<b>Dimmable - Cool White - 4000K</b>			
FC4BC/CW/D	2816-1868	BC / B22	480 lm
FC4ES/CW/D	2818-4533	ES / E27	480 lm
FC4SBC/CW/D	2818-4545	SBC / B15	480 lm
FC4SES/CW/D	2818-4557	SES / E14	480 lm

### 2.8W Essential LED Candle Lamps

- Suitable replacement for 25W filament lamps
- Finish: Opal
- Lamp life: 15,000 hrs
- Guarantee: 1 Year



Fusion Ref	Code	Cap	Lumens
<b>Non-Dimmable - Warm White - 2700K</b>			
FEC2.8BC	2818-4563	BC / B22	252 lm
FEC2.8ES	2818-4566	ES / E27	252 lm
FEC2.8SBC	2818-4569	SBC / B15	252 lm
FEC2.8SES	2818-4572	SES / E14	252 lm

**Delivery options to suit you**  
Free national delivery on online orders over £50 - Free delivery from your local branch

LED LAMPS

4.7W Essential LED Candle Lamps

- Suitable replacement for 40W incandescent lamps
- Finish: Opal
- Lamp life: 15,000 hrs
- Guarantee: 1 Year



Fusion Ref	Code	Cap	Lumens
<b>Non-Dimmable - Warm White - 2700K</b>			
FEC4.7BC	2818-4575	BC / B22	470 lm
FEC4.7ES	2818-4704	ES / E27	470 lm
FEC4.7SBC	2818-0558	SBC / B15	470 lm
FEC4.7SES	2818-4725	SES / E14	470 lm
<b>Dimmable - Warm White - 2700K</b>			
FEC4.7BC/D	2818-4701	BC / B22	470 lm
FEC4.7ES/D	2818-4713	ES / E27	470 lm
FEC4.7SBC/D	2818-4722	SBC / B15	470 lm
FEC4.7SES/D	2816-1892	SES / E14	470 lm

2W LED Filament Candle Lamps

- Suitable replacement for 25W incandescent lamps
- Finish: Clear
- Lamp life: 15,000 hrs
- Guarantee: 2 Years



Fusion Ref	Code	Cap	Lumens
<b>Non-Dimmable - Warm White - 2700K</b>			
FFC2BC	2818-4818	BC / B22	250 lm
FFC2ES	2818-4821	ES / E27	250 lm
FFC2SBC	2818-4824	SBC / B15	250 lm
FFC2SES	2818-4827	SES / E14	250 lm

4W LED Filament Candle Lamps

- Suitable replacement for 40W incandescent lamps
- Finish: Clear
- Lamp life: 15,000 hrs
- Guarantee: 2 Years



Fusion Ref	Code	Cap	Lumens
<b>Non-Dimmable - Warm White - 2700K</b>			
FFC4BC	2818-4830	BC / B22	480 lm
FFC4ES	2818-4845	ES / E27	480 lm
FFC4SBC	2818-4863	SBC / B15	480 lm
FFC4SES	2818-4881	SES / E14	480 lm
<b>Dimmable - Warm White - 2700K</b>			
FFC4BC/D	2818-4842	BC / B22	480 lm
FFC4ES/D	2818-4860	ES / E27	480 lm
FFC4SBC/D	2818-4878	SBC / B15	480 lm
FFC4SES/D	2818-4896	SES / E14	480 lm

4W LED Filament Candle Amber Lamps

- Suitable replacement for 40W incandescent lamps
- Finish: Clear
- Lamp life: 15,000 hrs
- Guarantee: 2 Years



Fusion Ref	Code	Cap	Lumens
<b>Dimmable - Warm White - 2200K</b>			
FFC4BC/A/D	2816-1898	BC / B22	380 lm
FFC4ES/A/D	2818-4851	ES / E27	380 lm
FFC4SBC/A/D	2818-4869	SBC / B15	380 lm
FFC4SES/A/D	2818-4887	SES / E14	380 lm

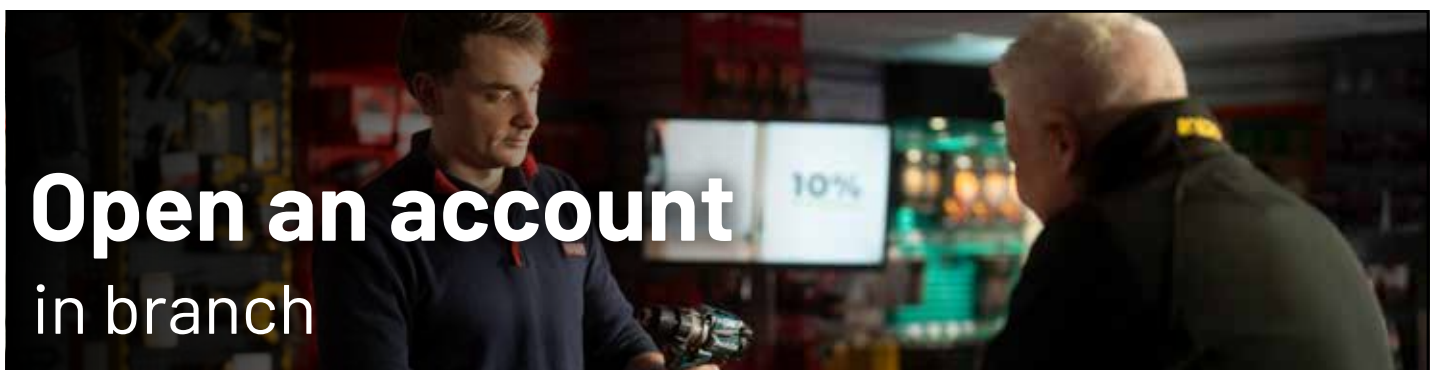

Open an account in branch

## LED LAMPS

### 4W LED Golf Ball Lamps



- Suitable replacement for 40W filament lamps
- Finish: Opal
- Lamp life: 25,000 hrs
- Guarantee: 3 Years



Fusion Ref	Code	Cap	Lumens
<b>Non-Dimmable - Warm White - 2700K</b>			
FDR4BC	2818-4659	BC / B22	480 lm
FDR4ES	2818-4665	ES / E27	480 lm
FDR4SBC	2818-4674	SBC / B15	480 lm
FDR4SES	2818-4686	SES / E14	480 lm
<b>Non-Dimmable - Cool White - 4000K</b>			
FDR4BC/CW	2818-0567	BC / B22	480 lm
FDR4ES/CW	2816-1874	ES / E27	480 lm
FDR4SBC/CW	2818-4677	SBC / B15	480 lm
FDR4SES/CW	2816-1877	SES / E14	480 lm
<b>Dimmable - Warm White - 2700K</b>			
FDR4BC/D	2818-4662	BC / B22	480 lm
FDR4ES/D	2818-4671	ES / E27	480 lm
FDR4SBC/D	2818-4683	SBC / B15	480 lm
FDR4SES/D	2818-4692	SES / E14	480 lm
<b>Dimmable - Cool White - 4000K</b>			
FDR4BC/CW/D	2816-1871	BC / B22	480 lm
FDR4ES/CW/D	2818-4668	ES / E27	480 lm
FDR4SBC/CW/D	2818-4680	SBC / B15	480 lm
FDR4SES/CW/D	2818-4689	SES / E14	480 lm

### 4.7W Essential LED Golf Ball Lamps



- Suitable replacement for 40W filament lamps
- Finish: Opal
- Lamp life: 15,000 hrs
- Guarantee: 1 Year



Fusion Ref	Code	Cap	Lumens
<b>Non-Dimmable - Warm White - 2700K</b>			
FEDR4.7BC	2818-4770	BC / B22	470 lm
FEDR4.7ES	2818-4782	ES / E27	470 lm
FEDR4.7SBC	2818-4794	SBC / B15	470 lm
FEDR4.7SES	2818-4806	SES / E14	470 lm

### 4W LED Filament Golf Ball Lamps



- Suitable replacement for 40W filament lamps
- Finish: Clear
- Lamp life: 15,000 hrs
- Guarantee: 2 Years



Fusion Ref	Code	Cap	Lumens
<b>Non-Dimmable - Warm White - 2700K</b>			
FFDR4BC	2818-4935	BC / B22	480 lm
FFDR4ES	2816-1901	ES / E27	480 lm
FFDR4SBC	2818-2760	SBC / B15	480 lm
FFDR4SES	2818-4944	SES / E14	480 lm
<b>Dimmable - Warm White - 2700K</b>			
FFDR4BC/D	2818-4938	BC / B22	480 lm
FFDR4ES/D	2816-1904	ES / E27	480 lm
FFDR4SBC/D	2818-4941	SBC / B15	480 lm
FFDR4SES/D	2818-4947	SES / E14	480 lm

### LED HID Alternative Lamps



- Ideal for miniature high bays, floodlights and lanterns
- Lamp life: 25,000 hrs
- Guarantee: 3 Years



Fusion Ref	Code	Wattage	Cap	Colour Temperature	Lumens
FHIDG12	2612-4382	8W	G12	4000K	1100 lm
EDLED/HID11	1414-1569	11W	ES / E27	6000K	1150 lm
EDLED/HID15	2253-2830	15W	ES / E27	6000K	1575 lm
FHID20/E27	2448-1897	20W	ES / E27	6000K	2600 lm



LED LAMPS

LED HID Discharge Lamps

- Ideal for low bays, high bays and floodlights
- Lamp life: 25,000 hrs
- Cap: E40 & E27
- Colour Temperature: 6000K Daylight
- Guarantee: 3 Years



Fusion Ref	Code	Wattage	Lumens
FHID30	2448-1900	30W	3900 lm
FHID30/E27	2448-1903	30W	3900 lm
FHID60	2448-1906	60W	8000 lm
FHID85	2448-1909	85W	11000 lm
FHID100	2448-1891	100W	13000 lm
FHID120	2448-1894	120W	15000 lm

# Branch opening hours

Mon-Fri 7:30-5:30 Sat 8:30-12:00

[local exceptions may apply]

## LED LAMPS

### LED Linear Lamps

- Ideal for retro fitting into floodlights and uplighters
- Cap: R7s
- Lamp life: 25,000 hrs
- Guarantee: 3 Years

Fusion Ref	Code	Wattage	Colour Temperature	Lumens
CRLED/78	2123-0995	5W	6000K	500 lm
CRLED/78WW	2146-8436	5W	3000K	450 lm
CRLED/118	2123-0977	9W	6000K	1050 lm
CRLED/118WW	2146-8433	9W	3000K	1000 lm
CRLED/118 110V	2236-2997	9W	6000K	1050 lm

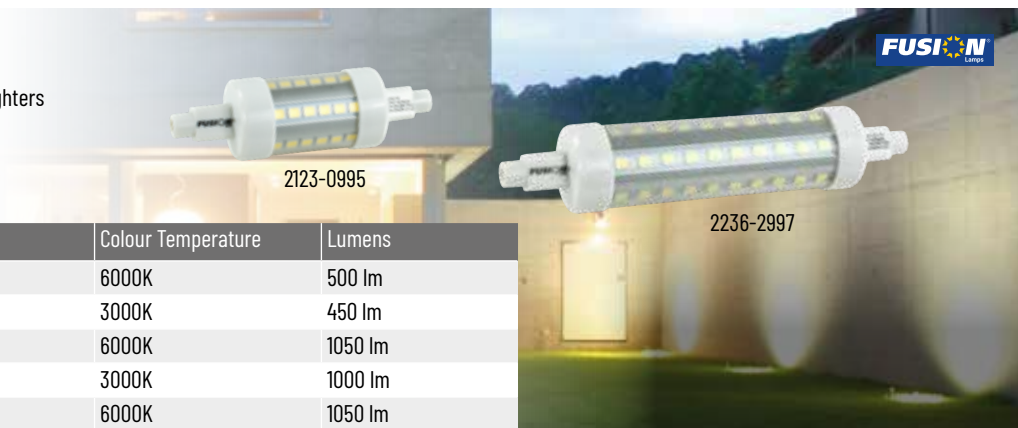

### 2W LED G4 Capsule Lamps - Pack of 2

- Suitable replacement for 10 and 20W halogen lamps
- Lamp life: 15,000 hrs
- Guarantee: 1 Year

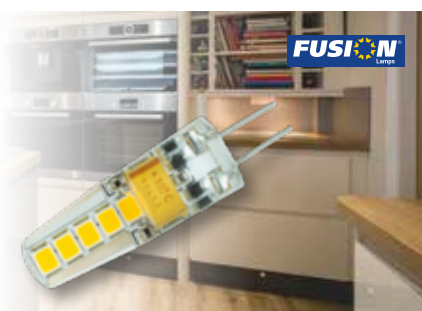

Fusion Ref	Code	Lumens
<b>Non-Dimmable - Warm White - 3000K</b>		
FG4/2P	2196-2761	200 lm
<b>Non-Dimmable - Cool White - 4000K</b>		
FG4CW/2P	2247-2401	200 lm

### 3.3W LED G9 Capsule Lamps - Pack of 2

- Suitable replacement for 40W halogen lamps
- Lamp life: 15,000 hrs
- Guarantee: 1 Year

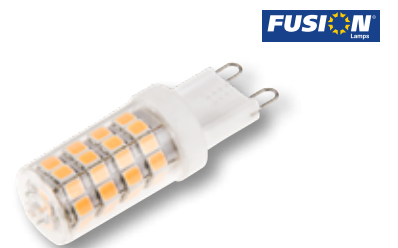

Fusion Ref	Code	Lumens
<b>Non-Dimmable - Warm White - 3000K</b>		
FG9/2P	2196-2764	350 lm
<b>Non-Dimmable - Cool White - 4000K</b>		
FG9CW/2P	2247-2404	350 lm



### 4.4W Dimmable LED G9 Capsule Lamps

- Suitable replacement for 40W halogen lamps
- 32 super bright SMDs
- Lamp life: 15,000 hrs
- Guarantee: 1 Year



Fusion Ref	Code	Colour Temperature	Lumens
FG9/D	2658-6514	3000K	470 lm
FG9CW/D	2705-9821	4000K	480 lm

### LED GY6.35 Capsule Lamps

- Ideal for interior lighting applications such as displays, shop windows and restaurants
- Lamp life: 15,000 hrs
- Guarantee: 1 Year



Fusion Ref	Code	Wattage	Lumens
<b>Non-Dimmable - Warm White - 3000K</b>			
FGY6.35/2.6WW	2786-2006	2.6W	300 lm
FGY6.35/4WW	2786-2012	4W	470 lm
<b>Non-Dimmable - Cool White - 4000K</b>			
FGY6.35/2.6CW	2786-2003	2.6W	300 lm
FGY6.35/4CW	2786-2009	4W	470 lm

### LED Pygmy Lamps

- Ideal for interior lighting applications such as displays, shop windows and restaurants
- Lamp life: 15,000 hrs
- Guarantee: 2 Years



Fusion Ref	Code	Wattage	Cap	Lumens
<b>Non-Dimmable - Warm White - 2700K</b>				
EDLED/FPT20SBC	2713-8352	1.5W	SBC	150 lm
EDLED/FPT20SES	2713-8355	1.5W	SES	150 lm
EDLED/FPT28BC	2713-8358	1.8W	BC	180 lm
EDLED/FPT28ES	2713-8361	1.8W	ES	180 lm

LED LAMPS

2W LED Cooker Hood Lamp

- Suitable replacement for 40W cooker hood lamps
- Finish: Clear
- Lamp life: 15,000 hrs
- Guarantee: 2 Years



LED Striplights

- Suitable replacement for 30W and 60W filament lamps
- Finish: Opal
- Lamp life: 20,000 hrs
- Guarantee: 2 Years



Fusion Ref	Code	Cap	Lumens
Non-Dimmable - Warm White - 2700K			
EDLED/FH00DSES	2196-3070	SES / E14	180 lm

Fusion Ref	Code	Wattage	Cap	Length	Lumens
Non-Dimmable - Warm White - 3000K					
CRLED/221	2302-6582	4W	S15s	221 mm	350 lm
CRLED/284	2302-6585	6W	S15s	284 mm	550 lm



Our customers say **we're 'excellent'**



[4.6/5] AS OF MAY 2026



# There's always a CEF near you

Over 390 branches  
nationwide

**Friendly experts**  
who are ready to  
help you find a  
**wide range** of  
essential electrical  
products at a  
branch near you!

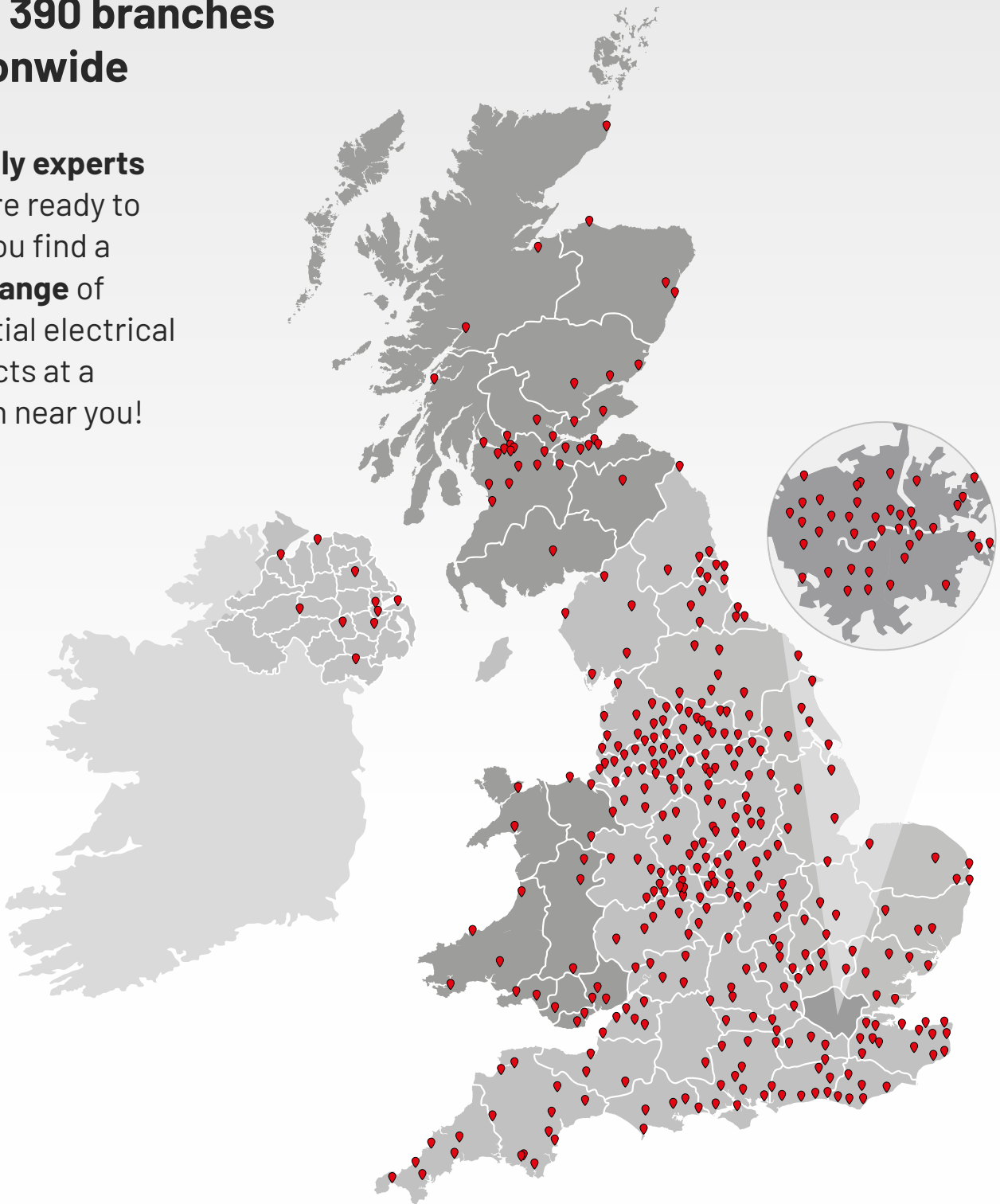

YOUR  
ELECTRICAL  
EXPERTS

Contact your local branch for more details



5 025110 925352 >  
LIGHTING ESSENTIALS